

Application

HT series distribution box use high-quality fire-resistant and PC materials reach IP65 protection Degree the max current can be 125A. Can be used in outdoor environment to protect the heavy weather.



Specifications

Product Model	Product Size	Product Weight
HT-2WAY	50*115*70	0.15KG
HT-5WAY	115*160*90	0.35KG
HT-8WAY	200*150*90	0.5KG
HT-12WAY	250*193*106	0.8KG
HT-15WAY	305*195*106	0.88KG
HT-18WAY	360*195*106	1.1KG
HT-24WAY	270*350*106	1.33KG

Features

1. Good waterproof performance
2. PG/M series connectors
3. Higher intensity and more durable
4. Flame retardant, uv protection, PC plastic
5. Din rail accessory
6. Mount and split are convenient

Dimension

Product Model	L (long)	W (width)	H (high)
HT-2WAY	50mm	115mm	70mm
HT-5WAY	115mm	160mm	90mm
HT-8WAY	200mm	150mm	90mm
HT-12WAY	250mm	193mm	106mm
HT-15WAY	305mm	195mm	106mm
HT-18WAY	360mm	195mm	106mm
HT-24WAY	270mm	350mm	106mm

Specifications



Product Model	Product Size	Product Weight
HA-4WAY	140*210*100	0.52KG
HA-8WAY	215*210*100	0.78KG
HA-12WAY	295*260*140	1.46KG
HA-18WAY	410*285*140	1.93KG
HA-24WAY	300*420*140	2.34KG

Dimension

Product Model	L (long)	W (width)	H (high)
HA-4WAY	140mm	210mm	100mm
HA-8WAY	215mm	210mm	100mm
HA-12WAY	295mm	260mm	140mm
HA-18WAY	410mm	285mm	140mm
HA-24WAY	300mm	420mm	140mm

Specifications



Product Model	Product Size	Product Weight
SH-4PN	105*200*100	0.4KG
SH-6PN	165*200*100	0.55KG
SH-9PN	220*200*100	0.8KG
SH-12PN	270*230*110	0.9KG
SH-18PN	380*230*110	1.2KG
SH-24PN	270*380*110	1.68KG
SH-36PN	381*380*110	2.25KG

Dimension

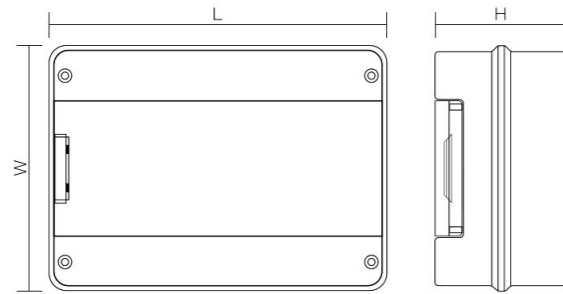

Product Model	L (long)	W (width)	H (high)
SH-4PN	105mm	200mm	100mm
SH-6PN	165mm	200mm	100mm
SH-9PN	220mm	200mm	100mm
SH-12PN	270mm	230mm	110mm
SH-18PN	380mm	230mm	110mm
SH-24PN	270mm	380mm	110mm
SH-36PN	381mm	380mm	110mm

Application



It is applicable for special waterproof, dustproof and corrosion-proof locations. Executive standard: IEC60529 EN 60309 IP67.

Specifications

Product Model	Product Size	Product Weight
HS-2WAY	57*101*28	0.082KG
HS-3WAY	75*101*28	0.1KG
HS-4WAY	93*101*28	0.12KG
HS-6WAY	124*101*28	0.17KG
HS-8WAY	160*101*28	0.18KG
HS-10WAY	196*101*28	0.27KG
HS-12WAY	232*101*28	0.3KG
HS-13WAY	250*101*28	0.32KG
HS-16WAY	304*101*28	0.35KG

Dimension

Model: 2WAYS

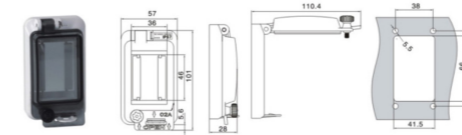

Model: 3WAYS

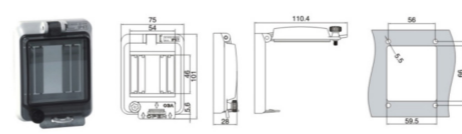

Model: 4WAYS

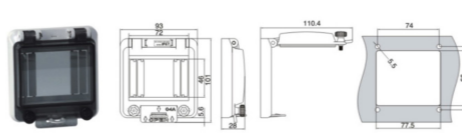

Model: 6WAYS

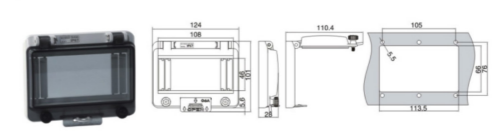

Model: 8WAYS

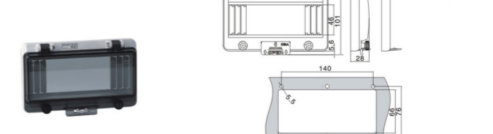

Model: 10WAYS

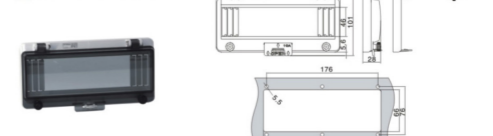

HS Series Transparent window cover

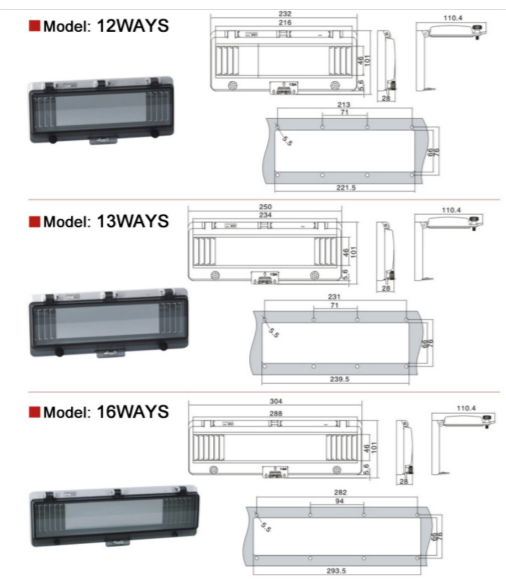

Product accessories

Attachment 1

- ① Hoisting bracket
- ② Hoisting bracket screw
- ③ Guide rail
- ④ Guide rail mounting screw



Note: additional accessories need to be purchased separately.